



cherish a radiant lifestyle

GALAXY
VEGA
2/3 BHK HOMES, GR. NOIDA (WEST)



creating homes, shaping lifestyles

The promoters of Panchtatva Promoters Pvt. Ltd. are a well known name in the realty sector and during all these years they had gathered years of valuable experience. With its experience, principles, and innovative architectural approach, it is bringing forth an extra ordinary project under the name, **Galaxy VEGA**. With this path-breaking project it is all set to bring in a remarkable change in the lifestyle of people who are going to dwell in these homes.

Panchtatva Promoters Pvt. Ltd. has all the skills required to be successful in this ever changing industry. With all this behind it the Group promises to bring in a remarkable change in the realty sector with its team of professionals who make it a technically sound group. The Group is renowned for its keen interest in upgrading technology in accordance with the latest trends. The Group along with its competent team dares to make and break the trends of the real estate industry.

ongoing projects

 2, 3 & 4 BHK Apartments at Rajnagar Extn., Ghaziabad	 2, 3 & 4 BHK Apartments at Rajnagar Extn., Ghaziabad	 2/3/4 BHK HOMES, NOIDA EXTN.	 2/3/4 BHK HOMES, NOIDA EXTN.	 plaza
--	--	----------------------------------	----------------------------------	-----------

upcoming projects



We all love getting a little extra and when it comes to our homes that perk gives us satisfaction no less than acquiring a kingdom. This is exactly what we at Galaxy Vega aim to do. Here you will find your dream homes in 2 and 3 BHK units loaded with dollops of contemporary luxuries. The spacious drawing room, well-designed bedrooms, airy bathrooms and the nature inviting balconies will make your life satiating. To add to your pleasure there is a vast green landscape with beautiful jogging trails and kids' park that will make you feel close to nature. The splendour of modern amenities matched with vast green expanse ensures that all its owners are pampered with a comfortable and premium lifestyle.

homes served
with an extra dollop
of luxury

Galaxy
VEGA
BHK HOMES, GR. NOIDA (WEST)





- Swimming pool and club featured with Gymnasium, Billiards table, Table Tennis, Card Table etc.*
- Firm Price - no escalation.
- Excellent location on 130 Mtr. wide road.
- Premium plot with 100 Mtr. Green belt facing Project.
- Certified earthquake resistant structure as per IS Codes of Practice.
- Lifts by OTIS/KONE/JOHNSON or equivalent in each block.
- Housing loan facility available from the leading financial institutions.
- Covered and open reserved car parking within the complex.*

convenience abounds here

- Parks, children play area, landscaping within the complex.
- Approx. only 20% covered area and 80% open space.
- Rain water harvesting.
- Plumbing done with CPVC pipes to avoid corrosion.
- Timely possession with penalty clause.
- Individual RO Unit for drinking water in each apartment.
- 100% Power back-up.*
- 24 Hour security with intercom facility.
- Adequate provision for fire fighting on each floor.
- Extra spacious room sizes, balconies and big windows to ensure most comfortable living



GALAXY
VEGA
2/3 BHK HOMES, GR. NOIDA (W)

LAXY
MEGA
 BHK HOMES, GR. NOIDA (WEST)



STRUCTURE

- Earthquake resistant RCC framed structure certified by IIT

EXTERNAL FINISH

- Excellent weather proof finish in pleasant shades

FLOORING

- Vitrified tiles in Drawing Room, Kitchen & Bedrooms
- Wooden laminated flooring in Master Bedroom
- Ceramic tiles in Bathrooms and Balconies

WALLS & CEILING FINISH

- Finished walls & ceiling with OBD in pleasing shades
- One wall in master bedroom duly textured finished

KITCHEN

- Granite working top with stainless steel sink
- 2'-0" dado above the working top and 5'-0" from the floor level on remaining walls by ceramic tiles
- Individual RO unit for drinking water

TOILETS

- Provision for hot and cold water system
- Ceramic tiles on walls up to door level

rich in
 every aspect

DOORS & WINDOWS

- White sanitary ware with EWC, Washbasin and CP fittings in all toilets
- Outer doors & windows aluminum powder coated/UPVC
- Internal door-frames of Maranti or equivalent wood
- Internal door made of painted flush shutters
- Main entry door frame of Maranti or equivalent wood with skin moulded door shutter
- Good quality hardware fittings

ELECTRICAL

- Copper wire in PVC conduits with MCB Supported circuits and adequate number of points and light points in ceiling

WATER SUPPLY

- Under ground and overhead water tanks with pumps for 24 hrs uninterrupted water supply

TV & TELEPHONE

- One landline connection having intercom facilities
- Provision for DTH connection



- The colour and design of the tiles and motifs can be changed without any prior approval
- Variation in the colour and size of Vitrified tiles/granite material
- Variation in colour in mica material
- Area in all categories of apartments may vary up to +3% without any change in price
- However, in case the variation is beyond +3%, pro-rate changes are applicable



MIG-1 : 2 BHK+2 Toilet+store • Super Area = 995.00 Sq. Ft.
Drawing | Dining | 2 Bedrooms | 2 Toilets | Kitchen | Store | 3 Balconies



MIG-2 : 2 BHK + 2 Toilet+Study • Super Area = 1195.00 Sq. Ft.
Drawing | Dining | 2 Bedrooms | Study Room | Kitchen | 2 Toilets | 3 Balconies



HIG-1 : 3 BHK + 2 TOILET • Super Area = 1340.00 Sq. Ft.
 Drawing | Dining | 3 Bedrooms | Kitchen | 2 Toilets | 3 Balconies

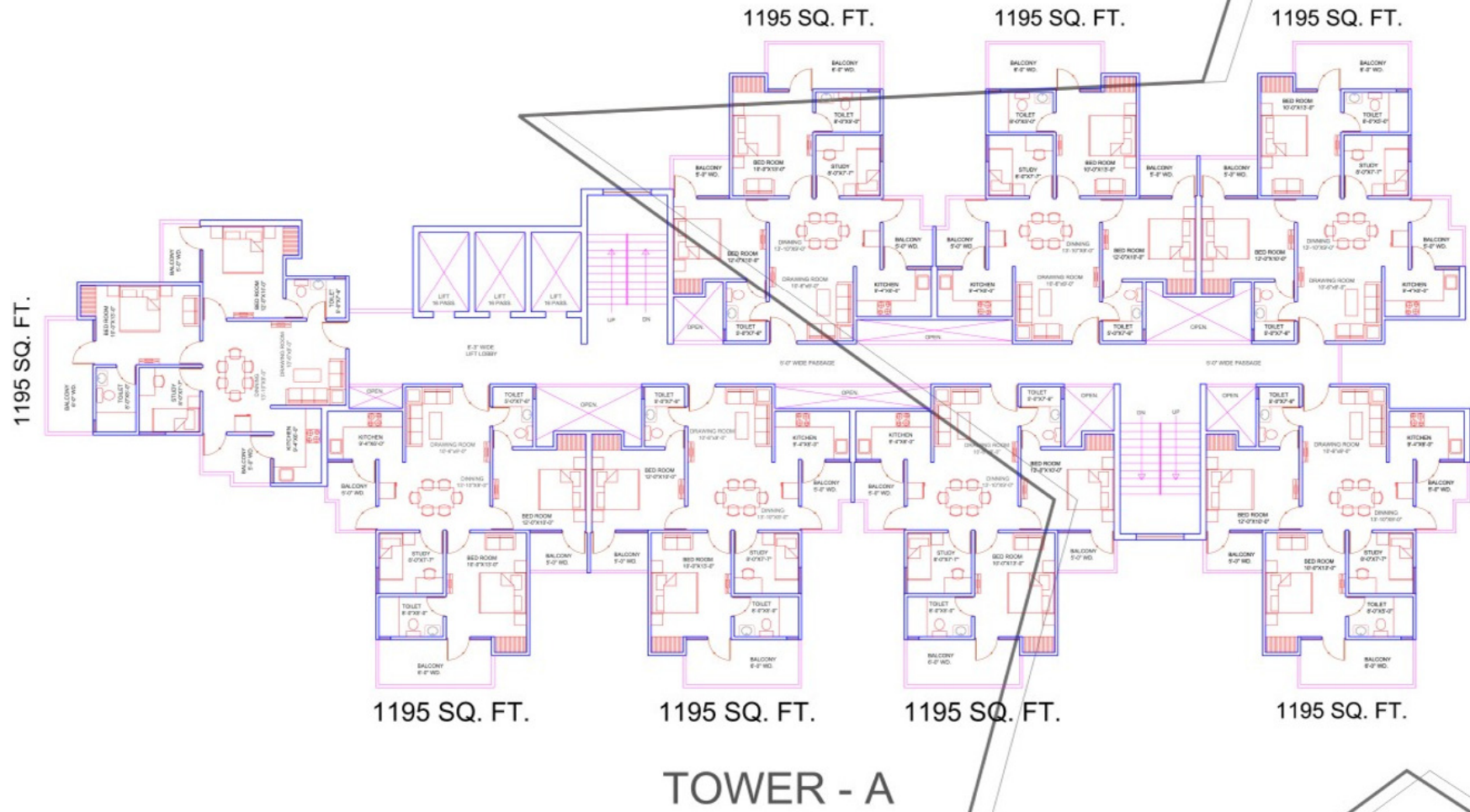

TOWER - A

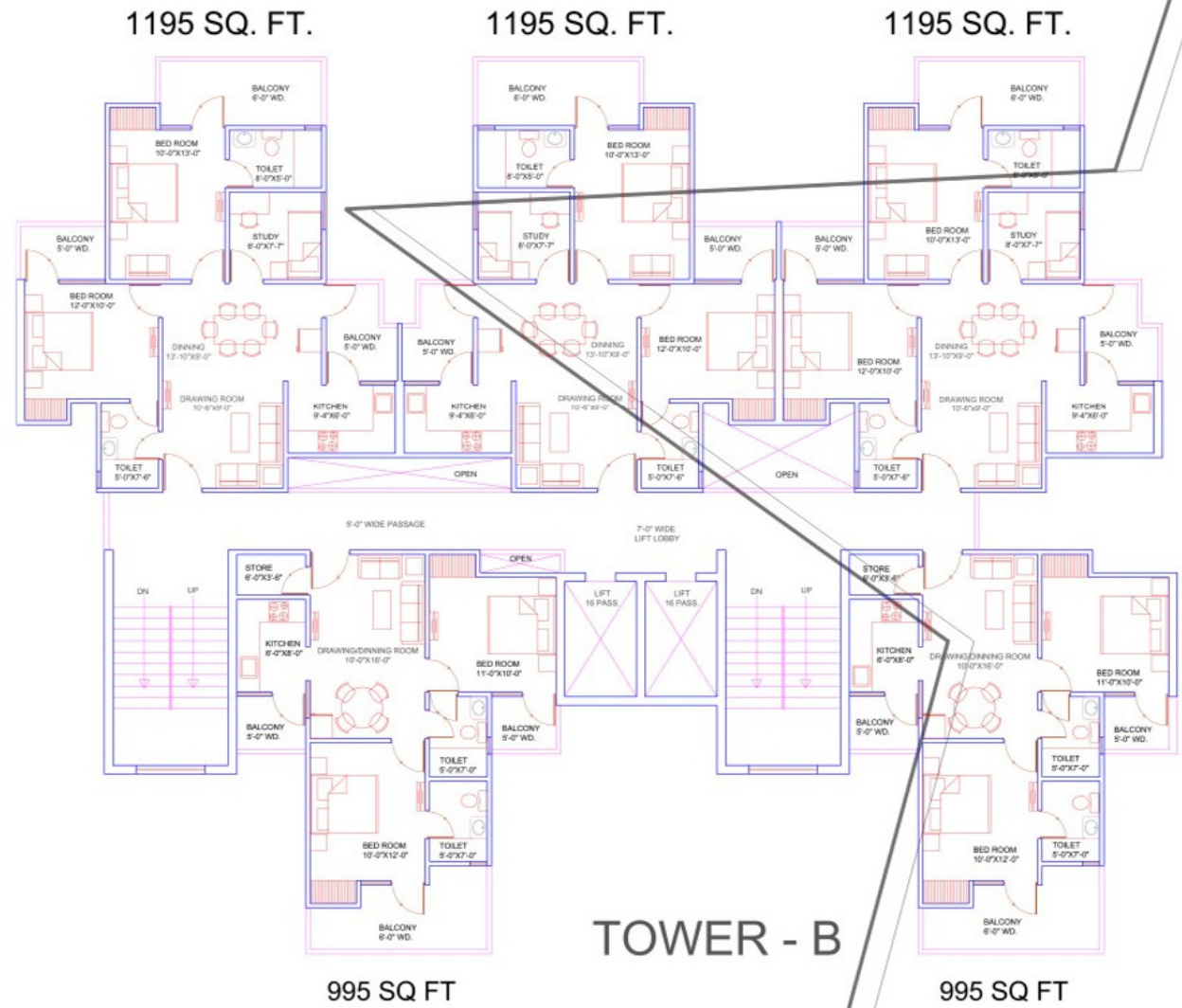

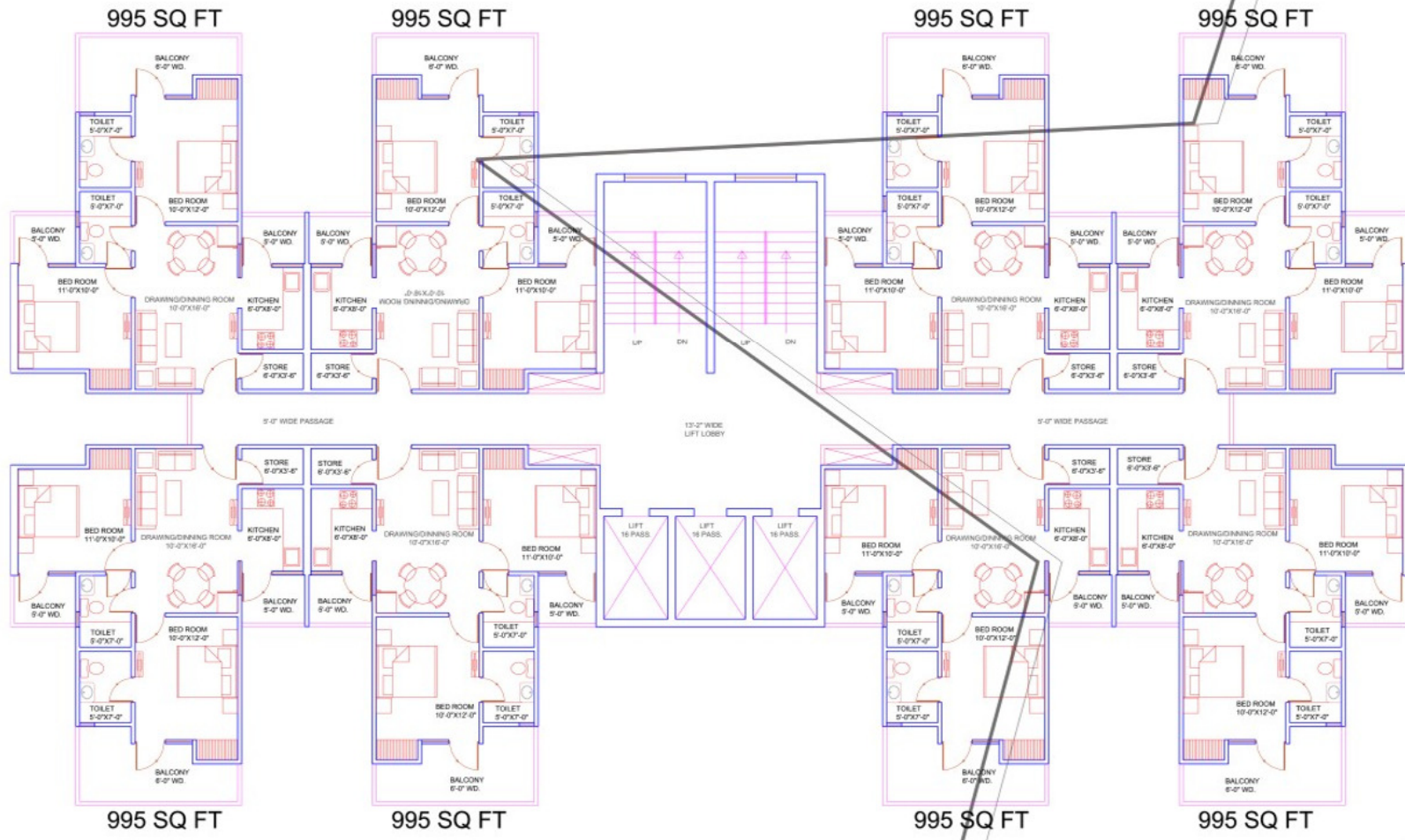

TOWER - C&D

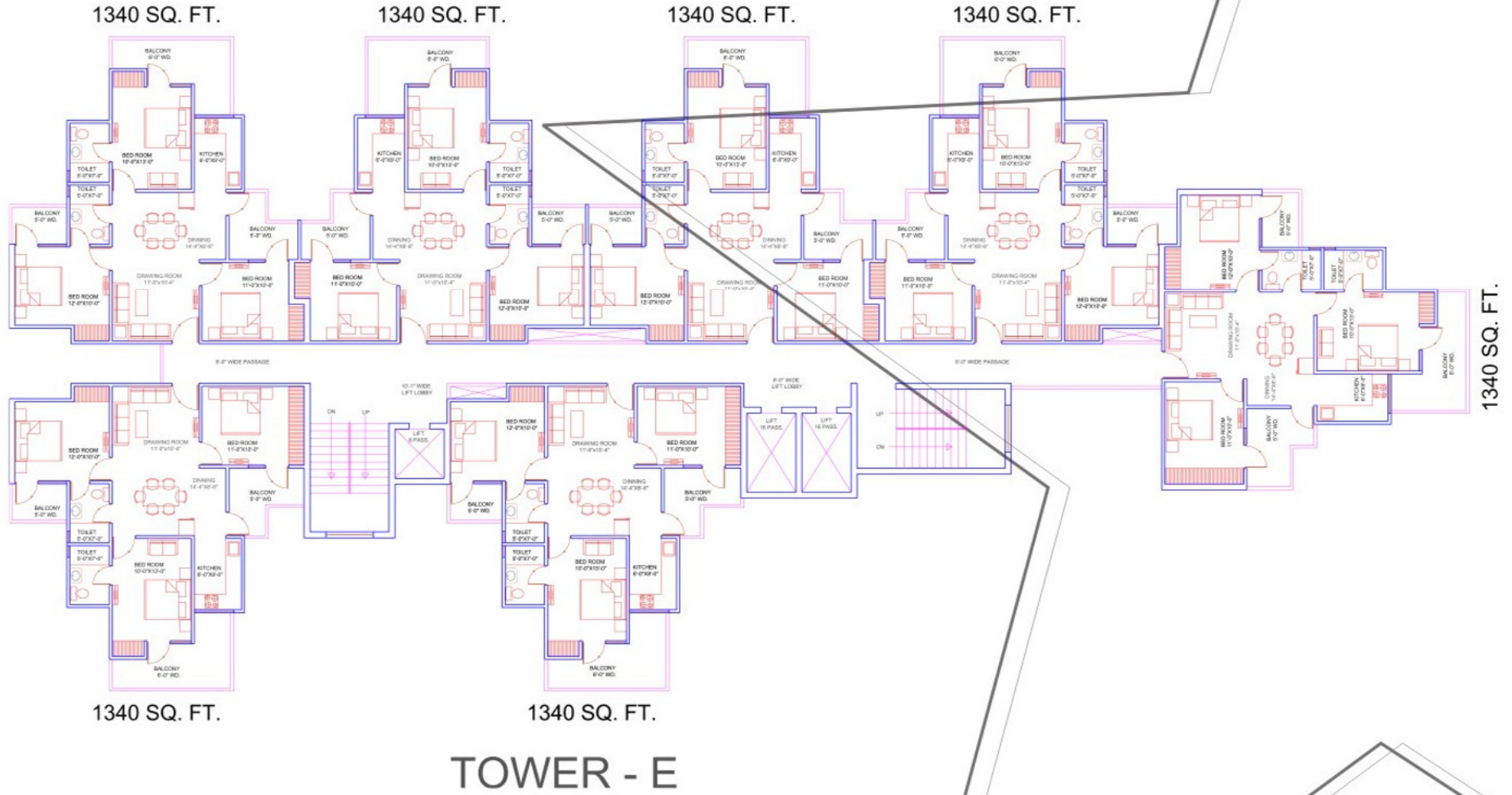

TOWER - E

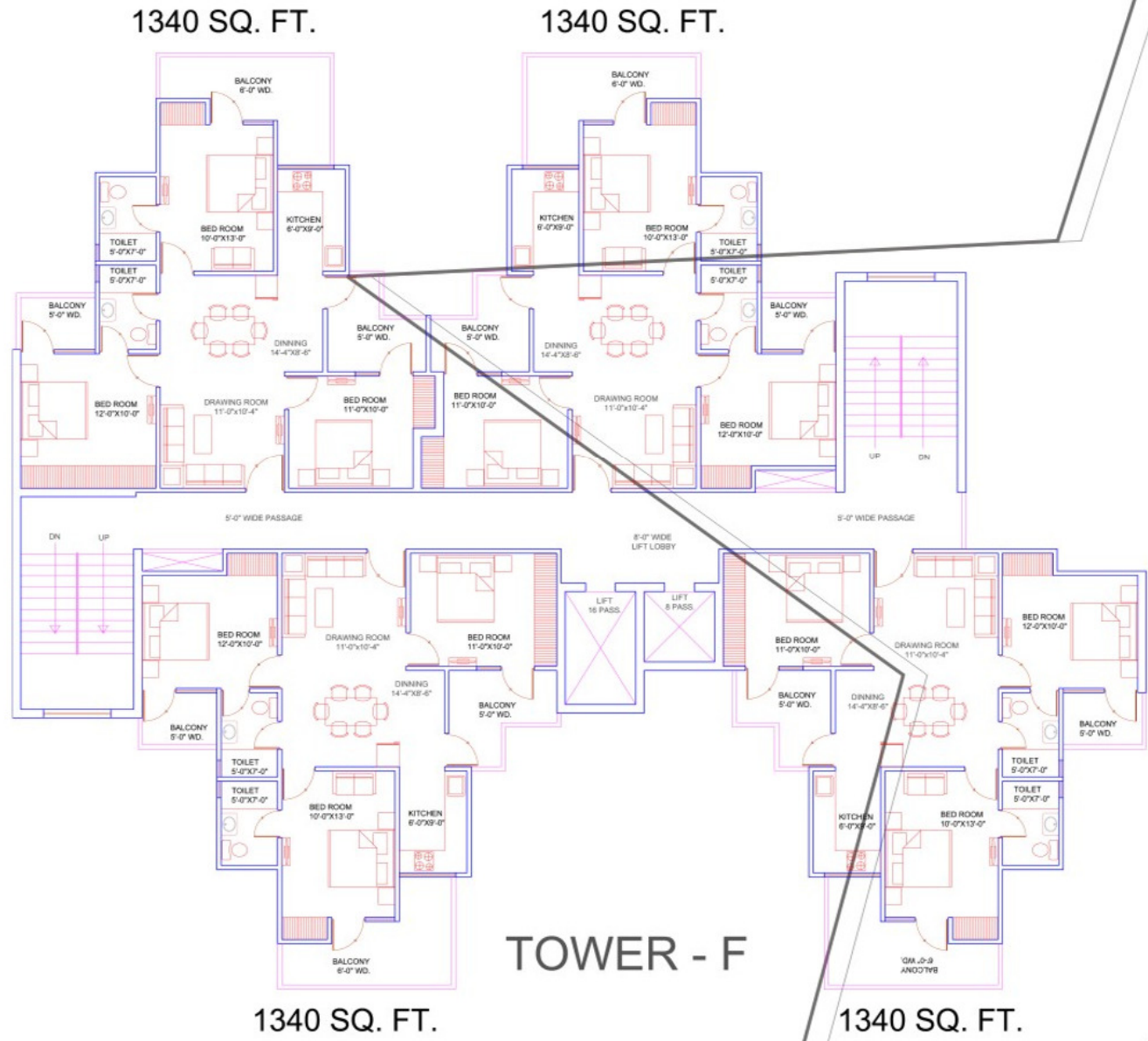

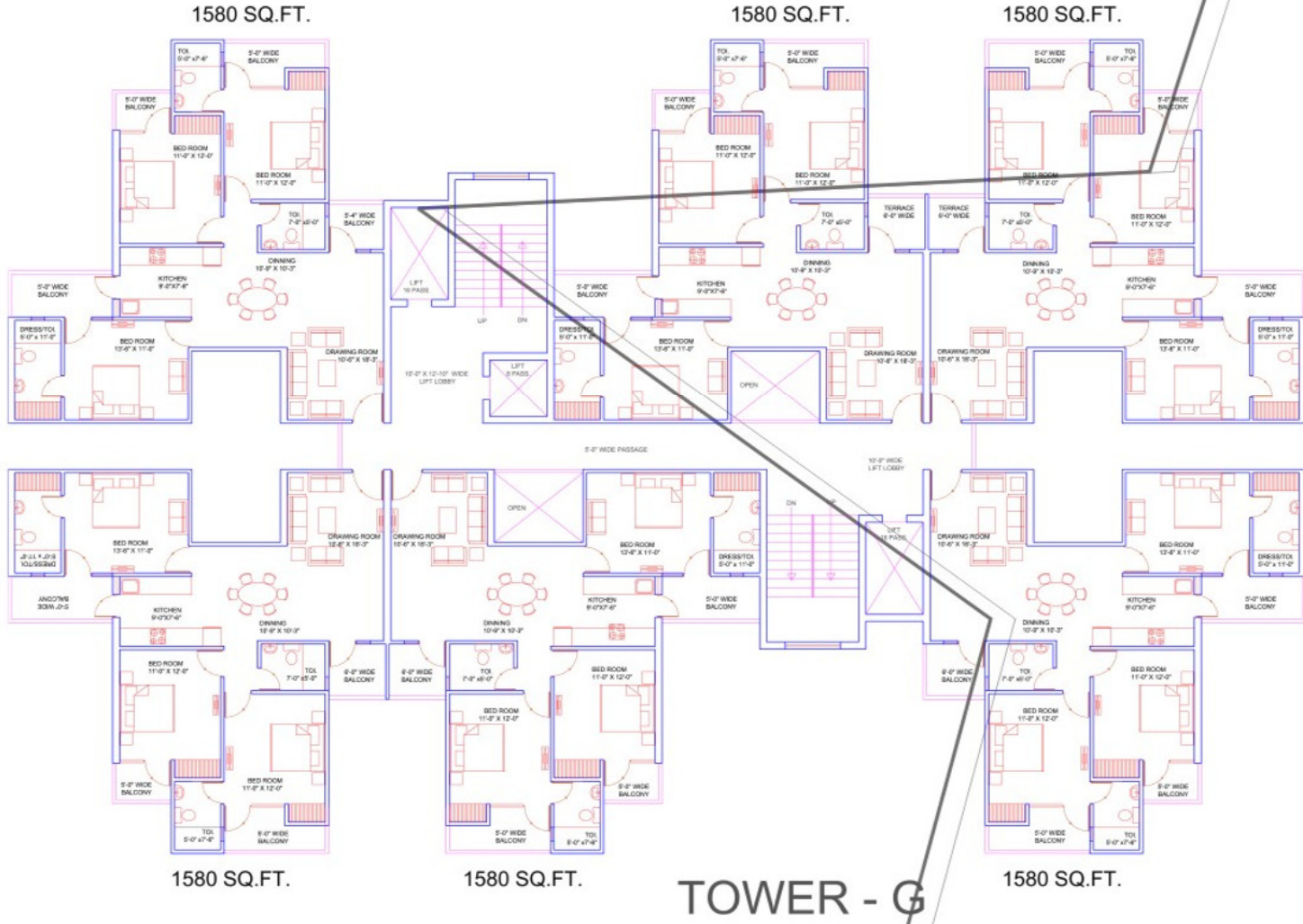

TOWER - G

S. No.	Specification
A	Guard Room and Entrance
B	Grass Slope
C	Mushroom Sculpture Court
D	Sun Deck & Fountain
E	Yoga & Meditation Garden
F	Stage
G	Amphitheater
H	Palm Court & Fountain
I	Party Lawn
J	Palm Court
K	Bamboo Grove
L	Badminton Court
M	Club
N	Pool Deck
O	Kid's Pool
P	Swimming Pool
Q	Sculpture with Water Wall & Sprouts Fountain
R	Flower Bed
S	Garden Gazebo
T	Kid's Play Area
U	Seating
V	Basket Ball Court
W	Screen Mound and Garden
X	Jogging Track
Y	Open Parking



S.No.	Legend	
	Area in (Sq. Ft.)	Unit Type
1.	1580	
2.	1340	
3.	1195	
4.	995	



LOCATION PLAN

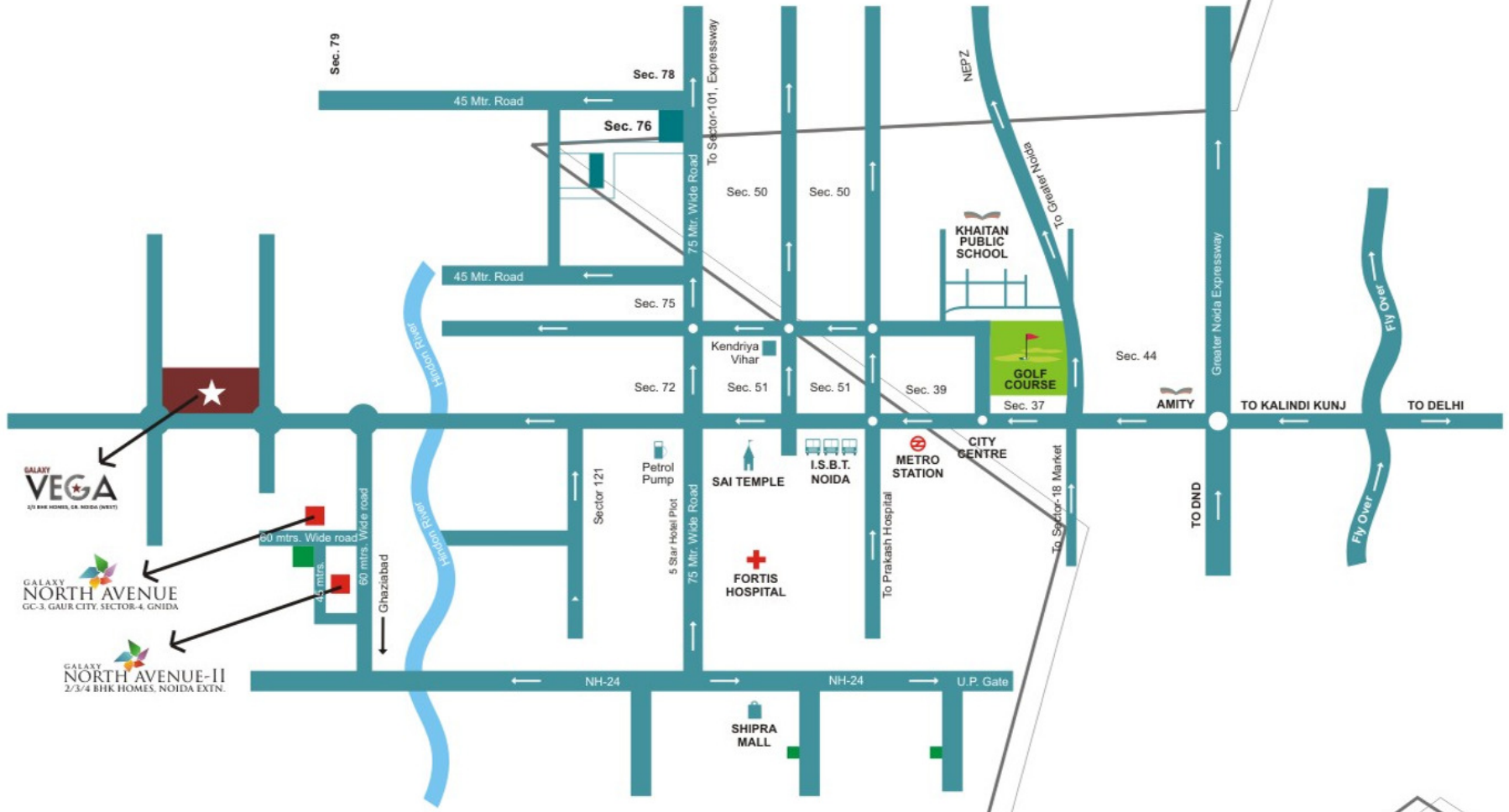



Panchtatva promoters pvt. ltd.

(A Galaxy Group Company)

Corp. Off.: H-95, Sector-63, Noida, (U.P.) • **Site Off.:** GH-08 C, Techzone- IV, GNIDA

Call: 8527044433, 8527144433, 8527244433

email: info@galaxyvega.com • www.galaxyvega.com